

DAWN STRAIGHT LINE CLAMPS - PUSH & PULL ACTIONS

Model 602-MM

604-MM
624-MM

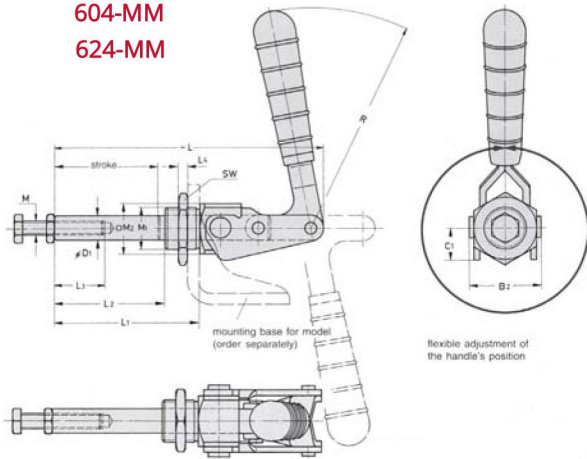

mounting bases

for model 602-MM
part no. **602106-M**
(order separately)

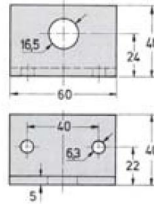

for model 604-MM
part no. **604106-M**
(order separately)

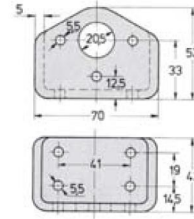

for model 624-MM
part no. **624106-M**
(order separately)

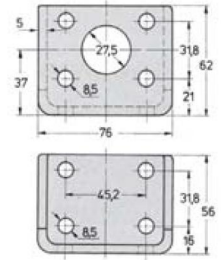

| Model No. | B2 | C1 | ØD1 | ~L | L1 | L2 | ~ | M | M1 | M2 | ~R | SW | |
|-----------|------|----|------|-----|----|------|----|-----|-----|-----------|----|-----|----|
| 602-MM | 26.5 | 11 | 9.5 | 62 | 33 | 20.5 | 15 | 6 | M6 | M16 x 1.5 | 19 | 69 | 24 |
| 604-MM | 33.5 | 11 | 11.1 | 110 | 56 | 40 | 25 | 6 | M8 | M20 x 1.5 | 22 | 95 | 30 |
| 624-MM | 48 | 20 | 1 | 170 | 92 | 7 | | 6.5 | M10 | M27 x 2 | 32 | 130 | 41 |

In stainless steel model : Models 602-SS, 604-SS, 624-SS

Model 606 - M

Light duty version

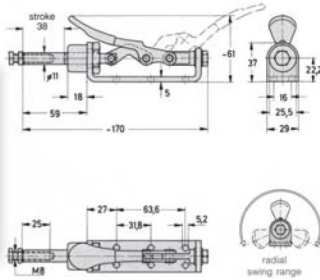
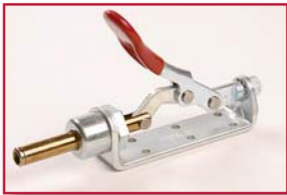

The handle and push rod can be rotated. The push rod does not lock in the open position.

Model 609 - M

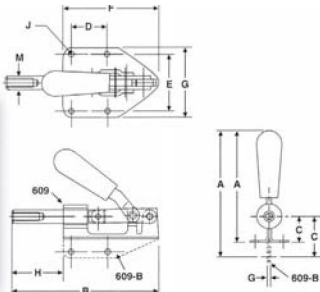

| A | B | C | D | E | F | G | H | J | M |
|------|-------|------|------|---|---|---|---|-----|------|
| 85.9 | 139.2 | 24.6 | 35.1 | 4 | | | | 5.1 | 12.7 |

Model 610 - M

Medium duty version

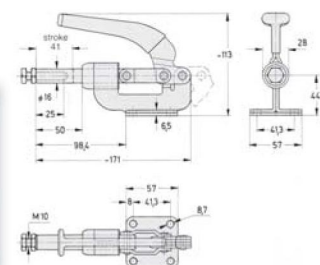

Model 620 - M

Medium duty version

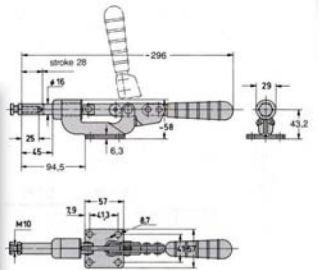

The handle and push rod move in opposite directions. The push rod does not lock in the open position.

Model 650 - M

Heavy duty version

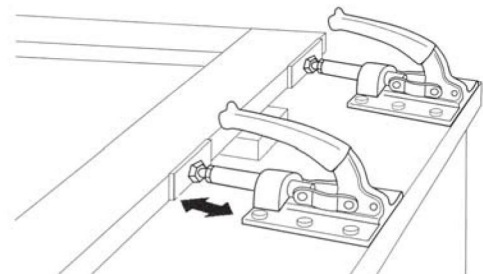
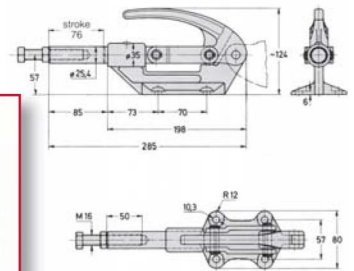

Model 604-MM



for model 604-MM
part no. **604106-M**
(order separately)

Recommended accessories
(order separately adjustment spindle)